

2019-320569-28-03-657677

--	--	--	--	--	--	--	--

1-2

1-3

% %

2

1-4

50% 50%

1-5

		200240	200240	0
		50649	50649	0
		250889	250889	0

1-6

4

5

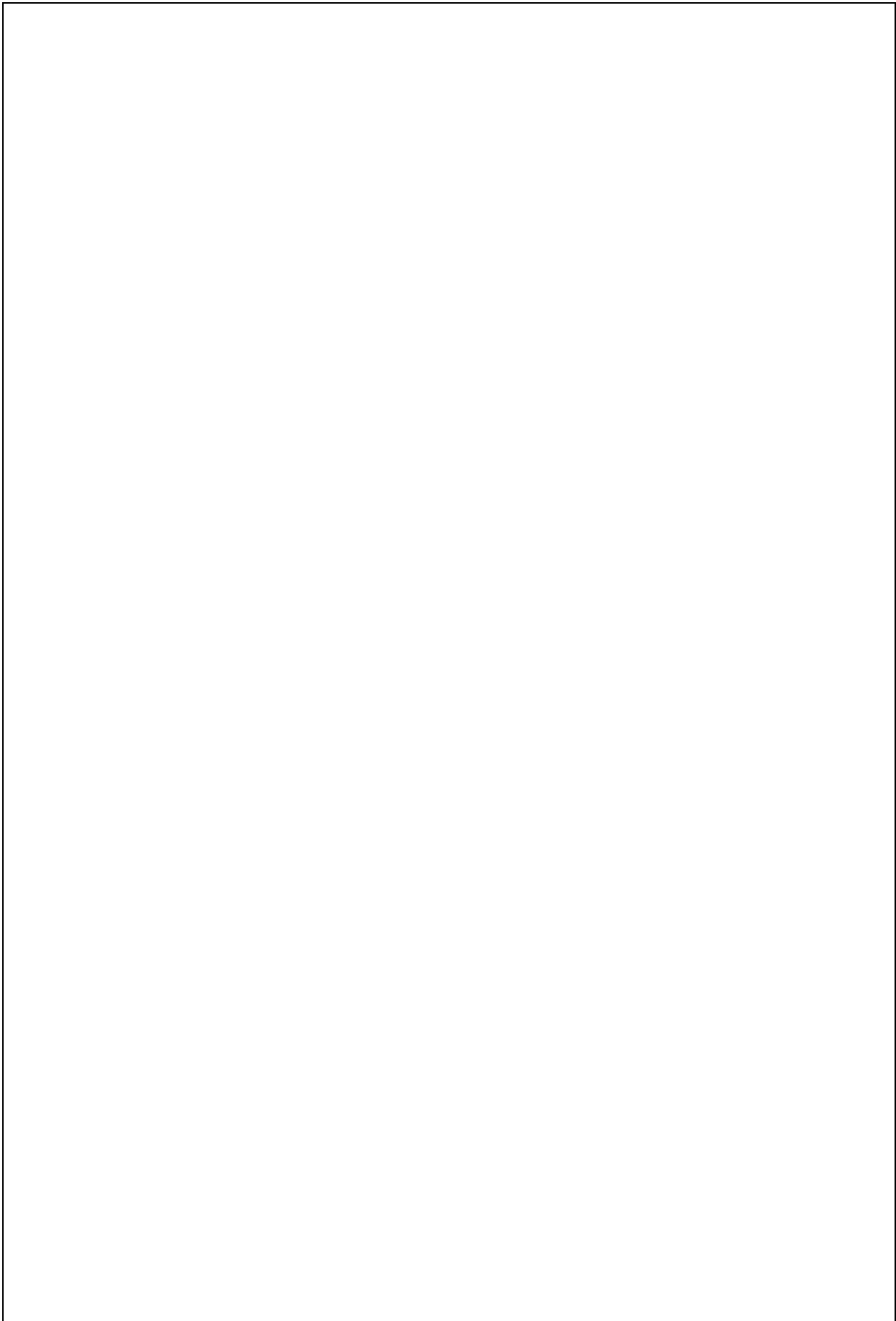

%&

DH

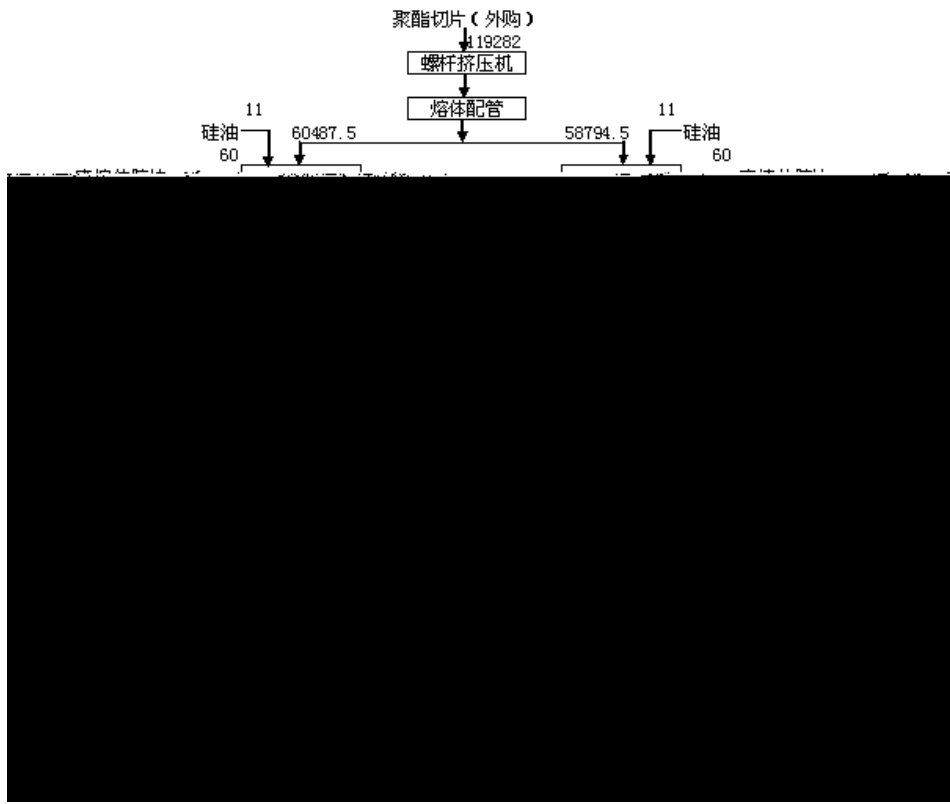

1-1 PTT

/

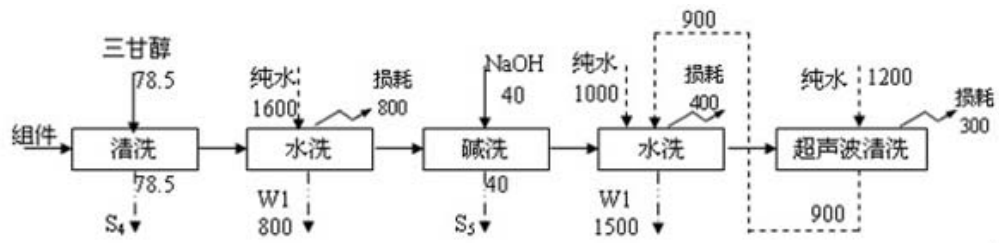

1-2 PTT

/

1-8 PTT

&S 78D

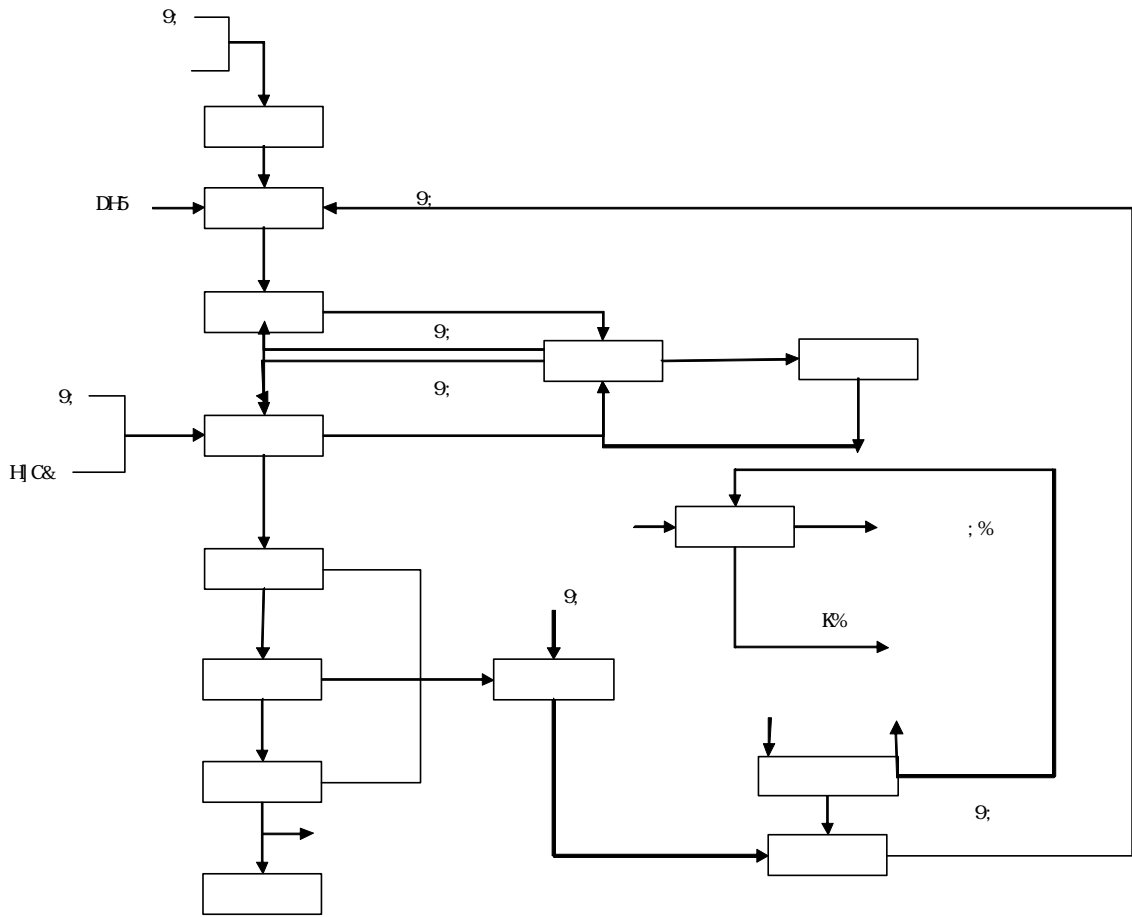

1-3 CDP

&
78D : 8Y DCY
DH
% 78D
& 78D ; %
; & ; '

G% 9 G& GD9
 G Q
 (9
 ' S~+) d6
 78D %%S

1-10 CDP

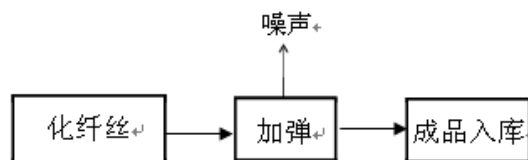

1-4

%

' SSSm#a

&

'

*Sh

(

, (~ \$d6

1-11 8

(S

1-12

		h#a	h#a	h#a
	7C8			
	GG			
	fl L			
	fl L			

1-13					t/a	

--	--	--	--	--	--	--

)\$

2 ' ...4i`Mp

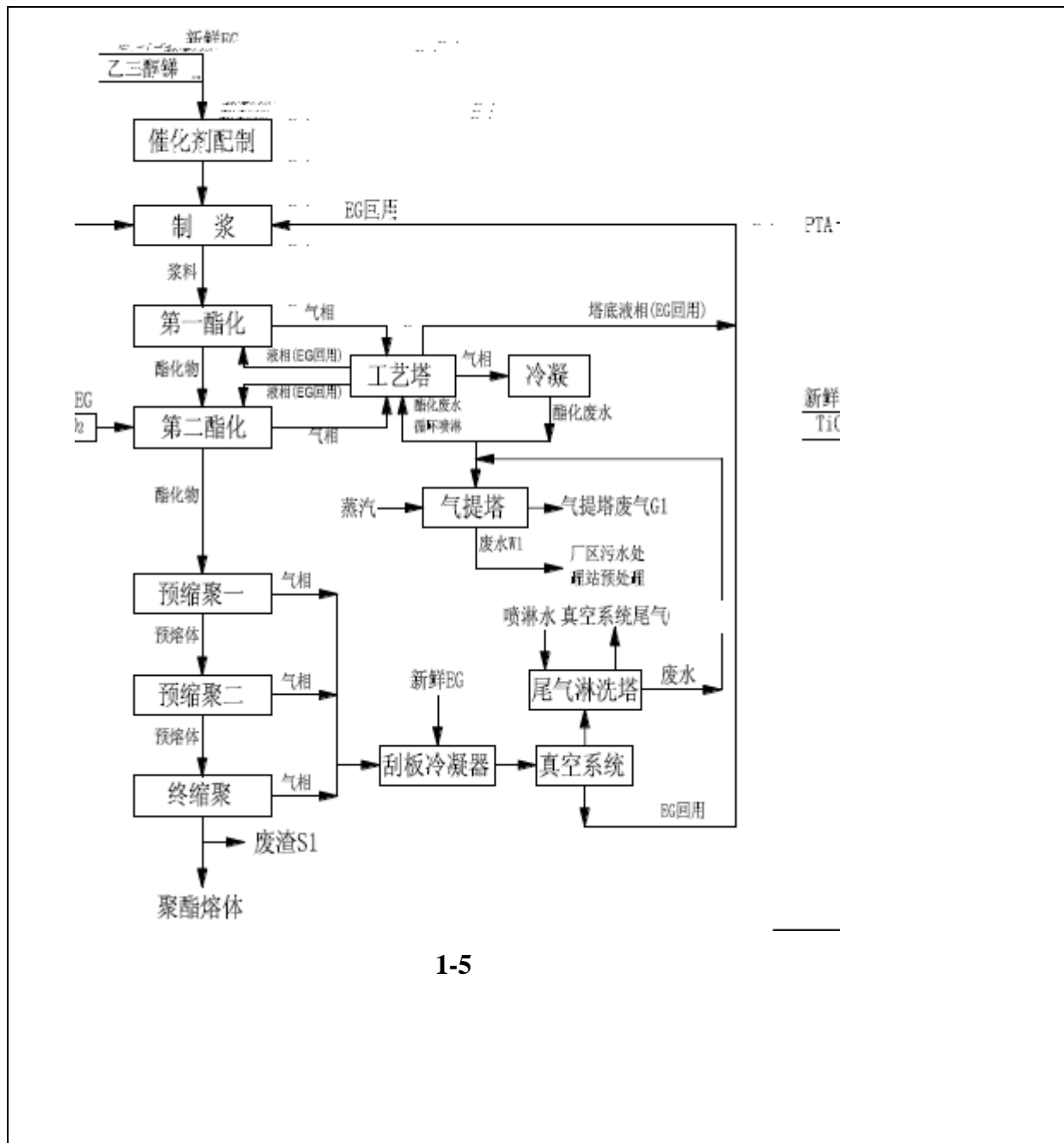

1-5

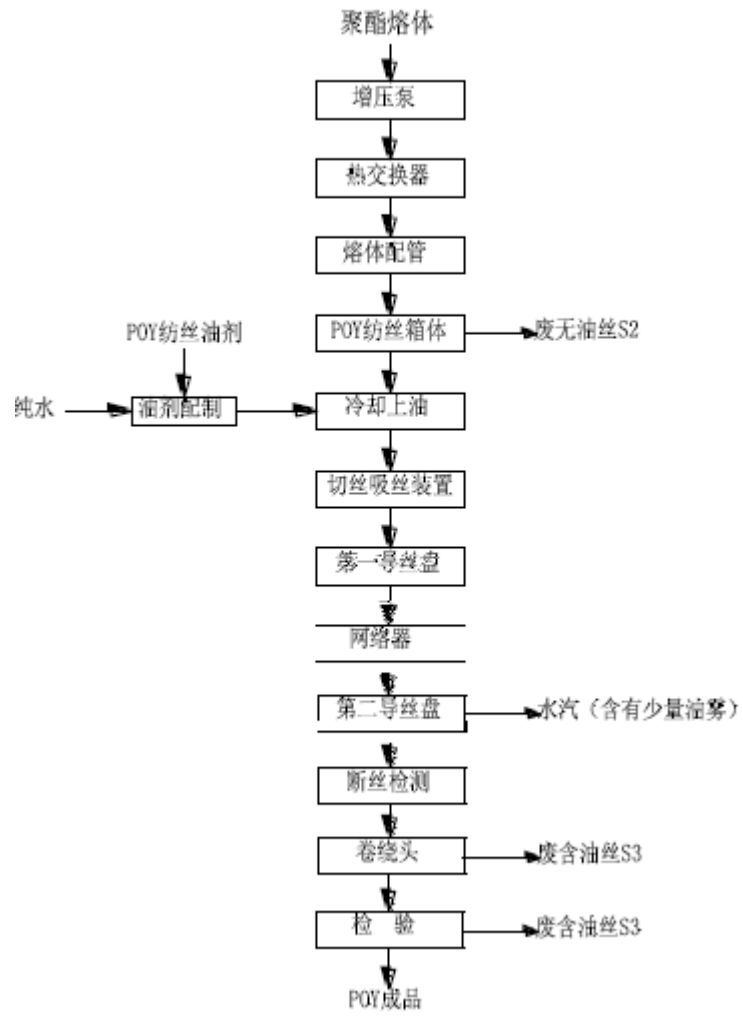

1-6 POY

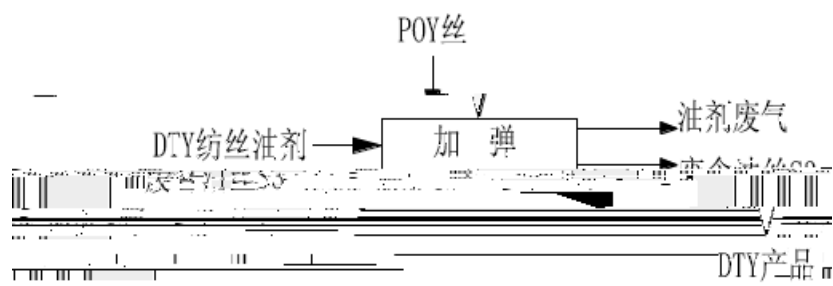

1-7

DTY

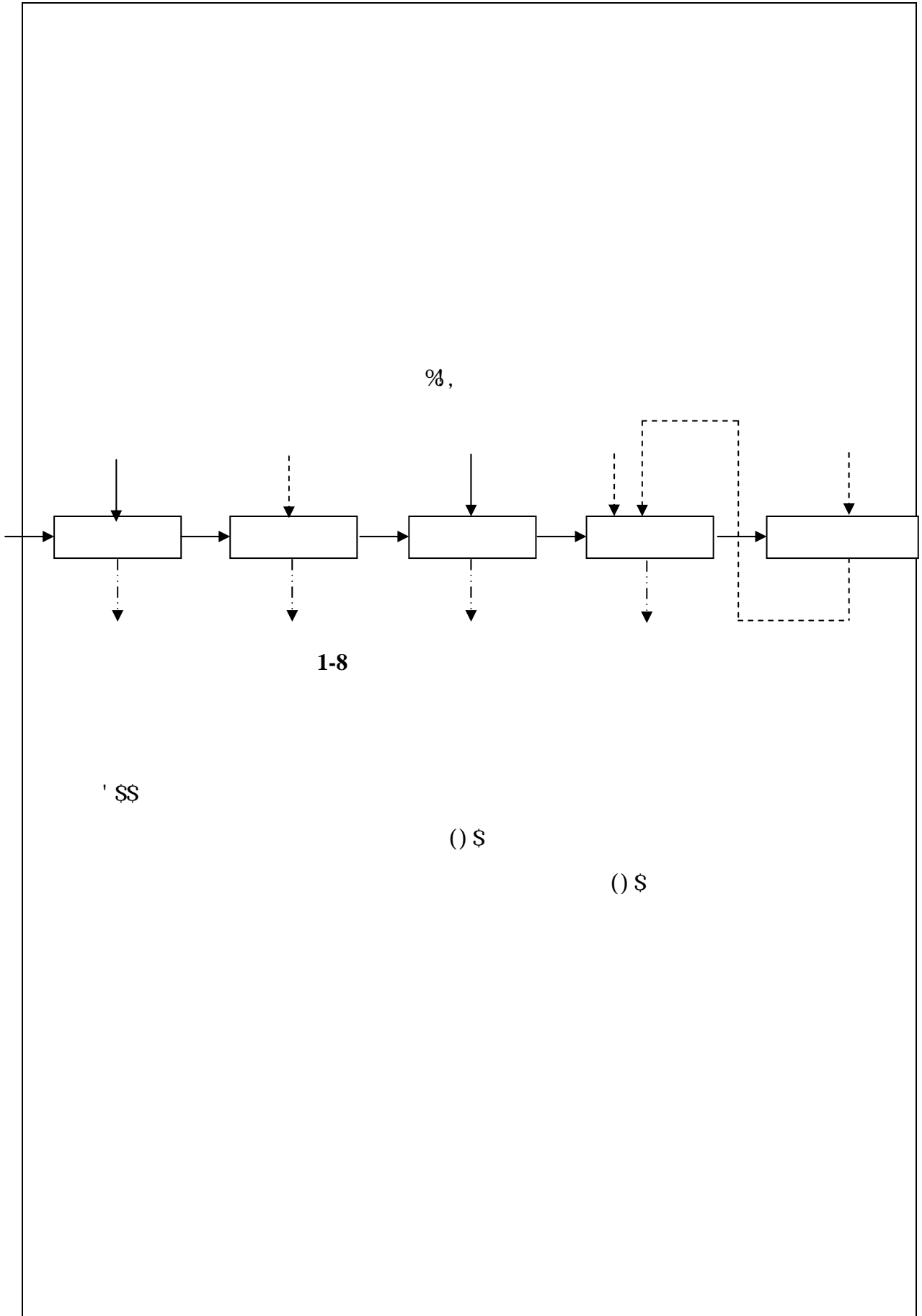

		1-14	50	t/a			

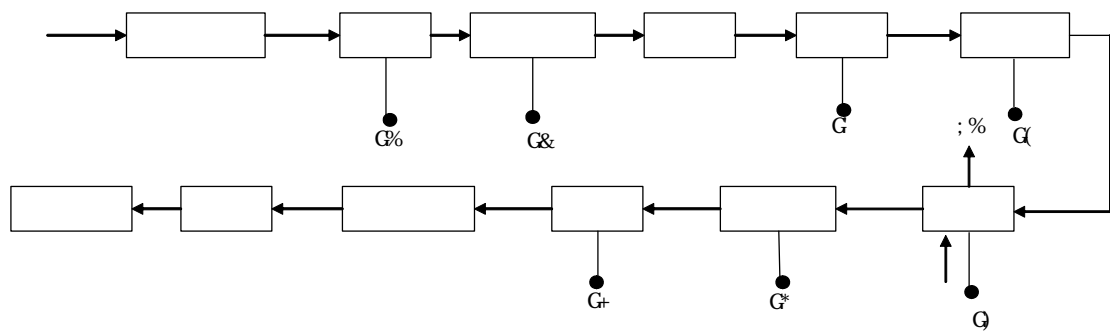

1-9 25

1-15 25

--	--	--	--	--

88% ,

(S

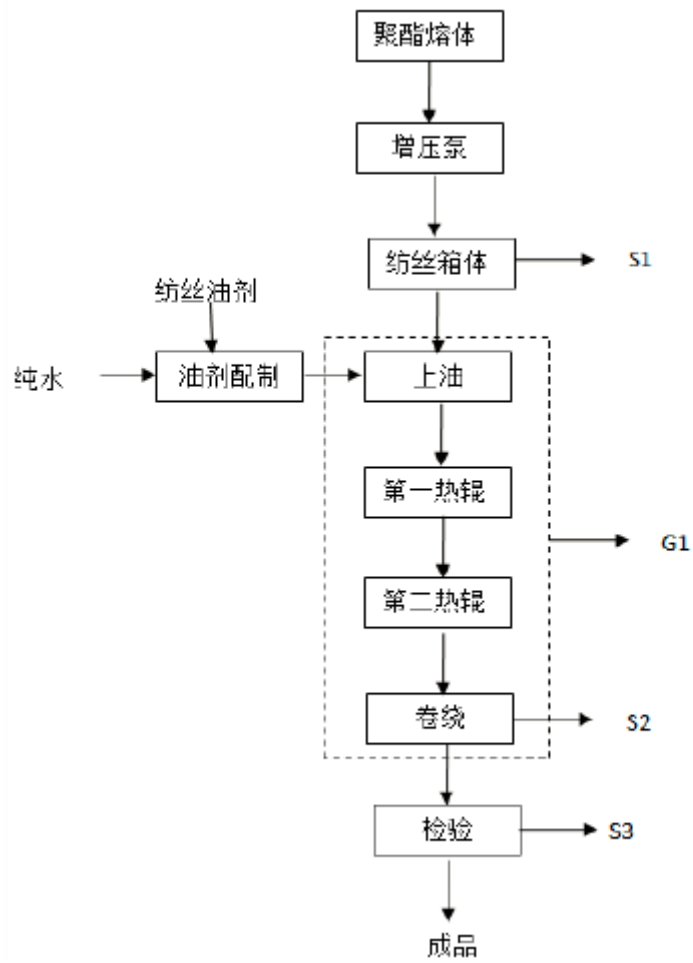

1-10 25

%

(S

: 8Y

88

#

: 8Y

% SSh#a) # : 8Y % # : 8Y

%(Sh#a) # : 8Y

: 8Y

% Sh#a

&

,

+) ~,) d6f5L

(

(% &S%+ , &&

' "%) &

1-16

&&%

&&&&

%

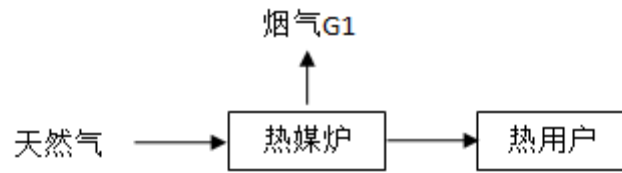

% %

h#a

1-18

t/a

&

%%

1-19

%

&&&& % %%

+

JC7g

&& 78D

(\$

)\$

JC7g

DH5

JC7g

JC7g

L85F

JC7g

JC7g

%&

DH

&

JC7g

JC7g

JC7g

JC7g

JC7g

&

)\$

% &\$

% &%

1-20



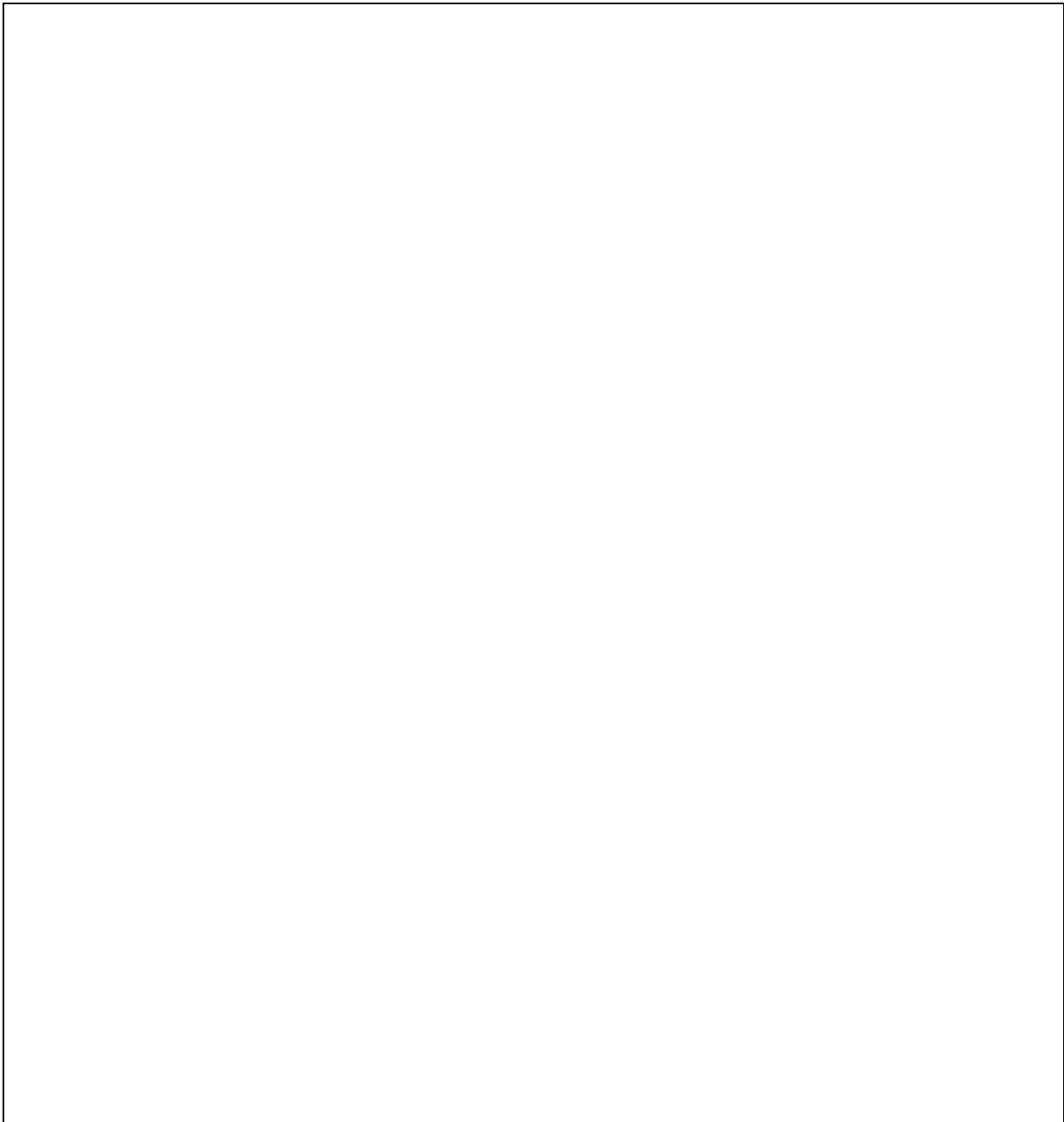

1

2

3

4

)' "'% km̂

%\$"*km̂

'\$"%

&*

("%&

')\$+

\$'+m

)', m̂

'*),

\$', m

)*% m̂

& km) \$, \$m %", km

)+"*

km

(\$",

%+ % \$m

!) "\$ \$

&&) m

(-%

%"* m

& %

' \$m#g

("%'

5

1

2

3



1

2014-2030

2

[2013]6

2-1

[2013]6

2018

2-2

(*

2-3

2-4

2-5

2-6

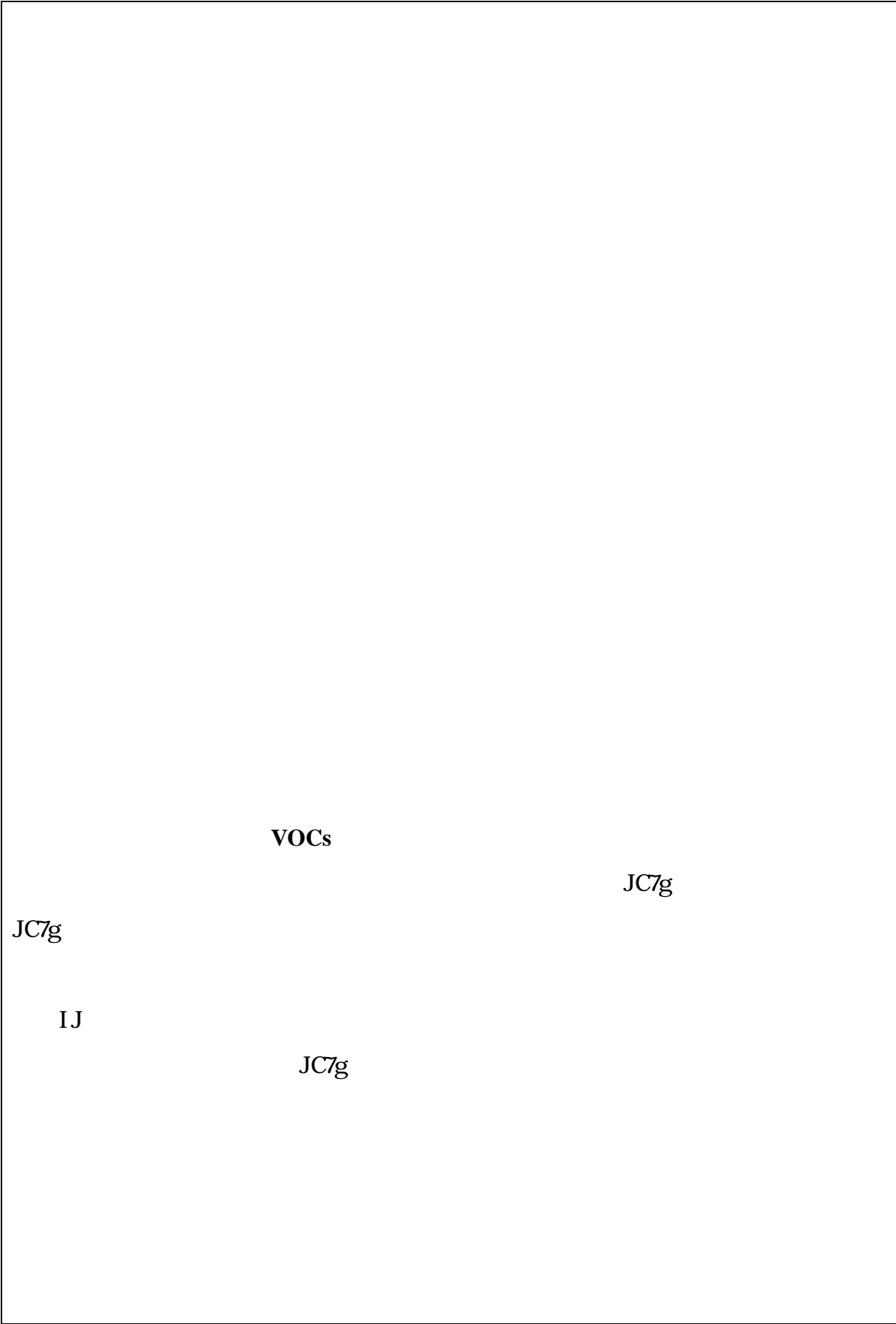

VOCs

JC7g

JC7g

IJ

JC7g

.....

.....

JC7g

JC7g

1

μ

μ

μ

μ

μ

3-1

CO mg/m³

ug/m³

2

3

3-2

4

3-3

3-4

3-5

	/m						/m

4-1

				μ			

4-2

4-3						

4-4							

4-5				

4-7					

1

5-1

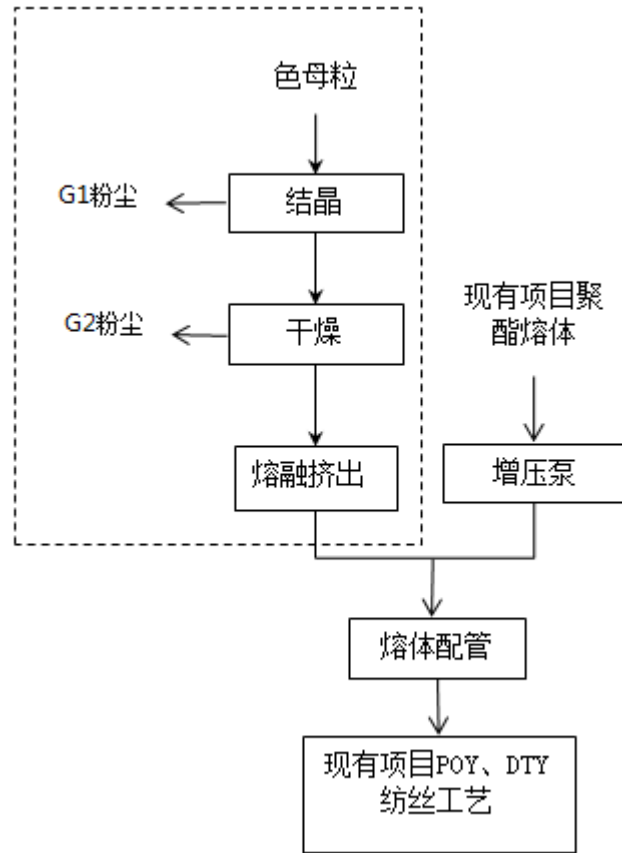

5-1

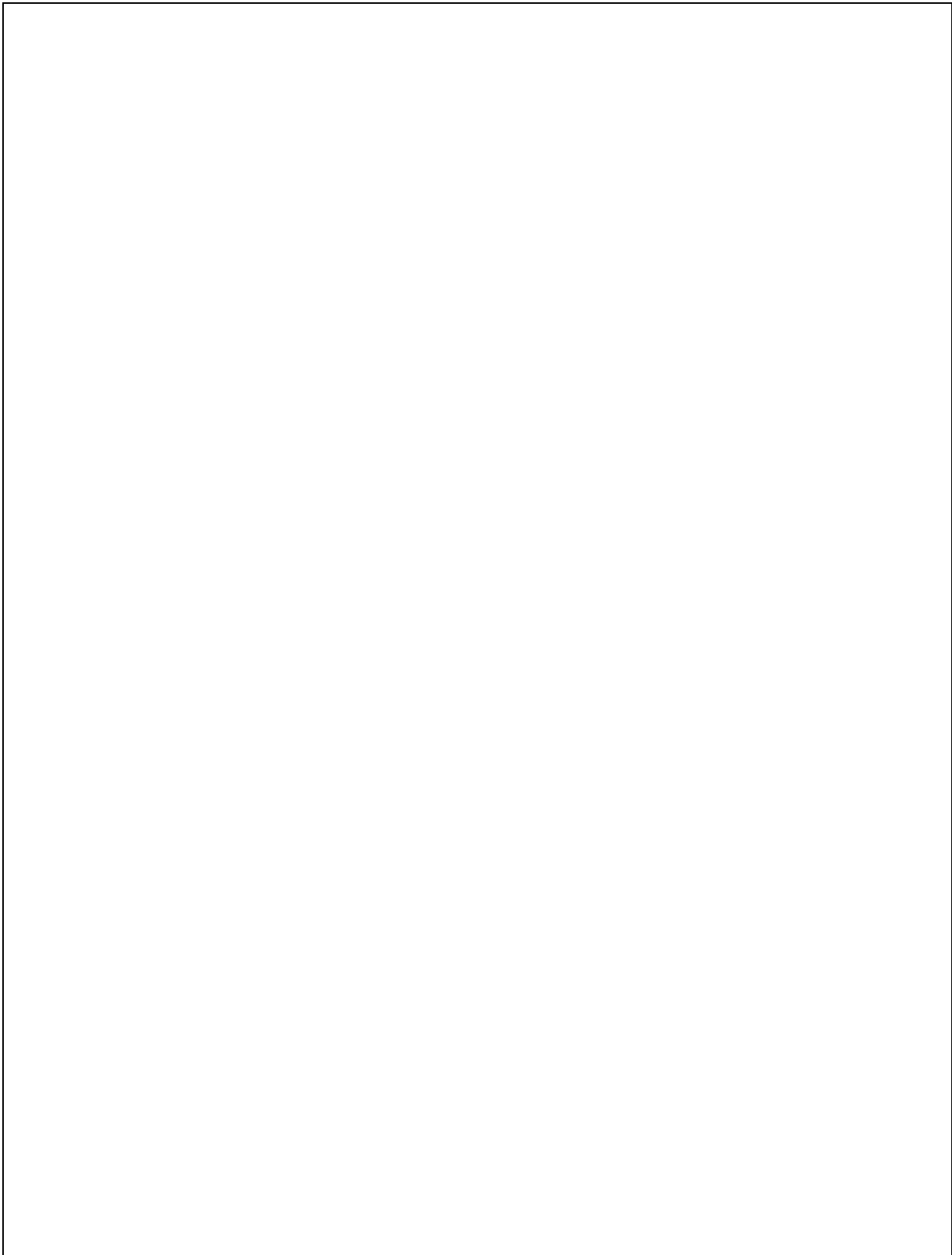

2

2.1

2.2

2.2.1

2.2.2

5-1

5-2

						$\mu\text{g}/\text{m}^3$	t/a

5-3

5-4

+

		t/a

5-5

+

		h/a

2.2.3

5-6

2.2.4

5-7

5-8

							/		
							/		

1

2

3

1

2.1

2.2

7-1

7-2

7-3

(3)

+!(

--	--

					✓
					-
					✓
		✓		-	
				✓	
				✓	
					✓
		✓			
					✓
				✓	
				✓	
		✓			
				✓	
				✓	

2.3

$$\frac{Q_c}{C_m} = \frac{BL^c}{A} + r L^D$$

C_m

Q_c

7-5

3

$$L_{Tp} = 10 \lg \left[\sum_{i=1}^n 10^{0.1 L_{pi}} \right]$$

7-6

dB(A)

4

7-7

5

7-8

/									

7-9

7-10

6.2

	---	---	---	---

“ ”

8-1 “ ”

					85	

8-2

													×	

1

2

3

4

5

&&% +(

[&&&]%

6

1

2

3

4

8

9-1

t/a

9-2

t/a

9

10

11

